

Input output multi function, board temperature controller

HANYOUNG NUX

BX8

INSTRUCTION MANUAL

We appreciate you for purchasing HanYoung NUX Co., Ltd product. Before using the product you have purchased, check to make sure that it is exactly what you ordered. Then, please use it following the instructions below.



HEAD OFFICE
1381-3, Juan-Dong, Nam-1
TEL: (82-32)876-4697 FAX: (82-32)876-4696

Safety information

Before using, please read this (SAFETY INFORMATION) and then use this controller. It is most important that the instructions in this manual are followed when using this instrument.

Please keep this manual for future reference.

Precautions are classified in **WARNING** and **CAUTION**.

WARNING	There is a possibility of death or heavy injury when handling in wrong way.
CAUTION	There is a possibility of injury or physical damage when handling in wrong way.

WARNING

- ① Caution on wiring
 - Use an external protection circuit if a fault in the control loop could possibly lead to a serious problem.
 - This instrument do not have a switch for power and a fuse, so please set them if it is needed. (Fuse rating 250V, 0.5A)
- ② Power supply
 - Use a rated voltage to prevent damage or trouble.
 - To avoid electrical shock or damage, do not turn ON the power until the wiring is completed.
- ③ Prohibit use in gas atmosphere
 - Do not use it at a place exposed to combustible or explosive gas.
- ④ Handling of unit
 - To avoid malfunction, electrical shock or fire, this unit must not be disassembled or repaired.
 - Do not touch the terminals to avoid electrical shock or malfunction.
- ⑤ Caution on maintenance
 - Turn OFF the power before mounting or removing the instrument.
 - To ensure continuous and safe operation of the instrument, periodical maintenance is recommended. Some parts are limited in life.
 - The warranty period is 1 year only if using in the correct way.

CAUTION

- ① Caution on handling
 - Do not install the instrument under any of the following conditions.
 - The ambient temperature exceeds 0 ~ 50°...
 - The ambient humidity exceeds 20 ~ 90%RH.
 - A place where temperature changes suddenly or icing occurs.
 - A place exposed to corrosive gas or combustible gas.
 - Vibration or shock is likely to be transmitted to the instrument.
 - A place exposed to water, oil, chemicals, steam, sunlight.
 - A place exposed to much dust, salt or iron.
 - A place with much inductive disturbance, static electricity, magnetism noise.
 - A place where heat such as radiant heat stays.
- ② Installation
 - This Controller does not have outer case and is only composed PCB(PRINT CIUCURT BOARD) so you need special attention when you install it to panel. Especially, influx of water or oil will cause electric shock or fire so you must check install place
- ③ Caution on terminal connections
 - Use a compensating cable with thermocouple.
 - For R.T.D input use a cable which is a small lead wire resistance and without resistance difference to 3wires.
 - To avoid inductive noise to input wires separate from the power and output wires.
 - Keep input wires away from output wires and use shielded wires to earth.
 - If the wiring has noise, use the following step: connect a surge absorber to the conductor coil side if the conductors are connected to the load output, such as the relay contact output.
 - Use an insulating transformer with a noise filter when the power supply has much noise.
 - Noise filter should be mounted on a panel which has been earthed and the wiring between the noise filter output and the instrument power terminals should be shorten.
 - It is effective to use a twisted cable for power supply against noise.
 - The heater power supply and the instrument power supply should be connected using the same power supply when a heater break alarm.
 - Time for preparation of contact output is required at power ON. When the output signal is used for an external interlock circuit, connect a delay relay.

- ④ For load circuit connection
 - Use an extra relay when the frequency of operation is rather high. In this case, SSR output type is Recommended.
 - Electromagnetic switch : Proportional cycle time is Min. 30sec
 - SSR : Proportional cycle time is Min. 1 sec
 - Contact output life : Mechanical : Min. 10 million times (no load)
Electrical : Min. 100 thousand times (rated load)
 - SSR drive pulse voltage, DC 4~20mA are not insulated with internal circuit.
Use non-grounded sensor to R.T.D and thermocouple.
- ⑤ Caution on key operation / trouble
 - If alarm function is not set correctly, alarm output can not be operated at a trouble. Be sure to check the alarm operation.
 - If the input cable is disconnected, the display shows "b.o.U.t" When replacing the sensor, please turn OFF the power supply.

Ordering information

Model	Code	Description
BX8	<input type="checkbox"/> <input type="checkbox"/>	48×48 mm Board Type Digital Temperature Controller
Control Type	0	Universal Type
	1	Heating/Cooling
Optional	0	SV2SV3
	1	HBA
	2	RS485
	3	HBA/RS485

SPECIFICATION

INPUT

Input	Thermocouple: K, J, E, T, R, S, B, L, N, U, WRε 5-26, PL R.T.D: Pt 100 Ω, KPt 100 Ω Direct voltage: 1~5V, -10~20mV, 0~100mV(Programmable scale type)
Sampling time	250mS
Input resolution	Below decimal point of measurement range
Input impedance	T/C and mV input: 1M Ω min., DC V: 1M Ω
Lead wire tolerable resistance	R.T.D: 10 Ω max. /wire
Input tolerable voltage	±10V (T/C, R.T.D, Voltage: mV DC) ±20V (Voltage: V DC)
Noise removal rate	NMRR(normal mode): 40dB min. CMRR(common mode): 120dB min. (50/60Hz ±1%)
Standard	T/C, R.T.D: KS, IEC, DIN
Standard junction temp. compensation tolerance	±1.5 °C(15~35°C), ±2.0 °C(0~50 °C)
Burn-out	T/C: OFF, Up/Down selectable R.T.D: Up scale (Detection current: 50nA)
Accuracy	±0.5% (Full scale)
Input range	Refer to "Input signal and Measurement range" T/C and R.T.D are changeable within range of input signal and measurement range. Voltage: min. voltage and max. voltage are available within range of measurement. Scaling available.

OUTPUT

ALARM(HBA OUTPUT)

Relay contact output	Contact capacity: 240VAC 1A, 30V DC 1A(resistive load) Contact: 1a Output points: Refer to "Terminal Arrangement"
Heater break alarm	Point: 1 point Current measurement range: AC 1~50A a.c (resolution: 0.5A, ±5% ±1digit of F.S) Alarm output: Selectable in Alarm types Deadband : 0~100% of max. range • HBA is available when On/Off control or proportional output (but, when current output or cooling control, HBA is not available) • Break detection is not possible in 0.2 sec. when output on.

RETRANSMISSION OUTPUT

Current output	Current output range: 4~20mA DC Resistive load: 600 Ω max. Accuracy: ±0.5% of max. scale (4~20mA range) Resolution: Approx. 3,000 Output ripple: 0.3% (P-P) max. of scale (150Hz) Sampling: 250mS
-----------------------	--

CONTROL OUTPUT

Relay contact output	Contact capacity: 240VAC 3A, 30VDC 3A (resistive load) Contact: 1C Output operation: P.I.D control, ON/OFF Proportional cycle: 1~1,000 sec. Output limit: 0.0~100.0% range, higher limit(OH) or lower limit(OL) selectable (valid when AT) ON/OFF hysteresis: 0~100%(Full scale) Time resolution: 0.1% or 10mS
SSR drive voltage output	ON voltage: 24VDC min. (resistive load 600 Ω min., 30mA limit when short) OFF voltage: 0.1VDC max. Proportional cycle: 1~1,000 sec. Output operation: P.I.D control Output limit: 0.0~100.0% range, higher limit(OH) or lower limit(OL) selectable (valid when AT) Time resolution: 0.1% or 10mS
Current output	Current output range: 4~20mA DC Resistive load: 600 Ω max. Accuracy: ±0.5% of full scale (4~20mA range), Resolution: Approx. 3,000 Output ripple: 0.3%(P-P) of max. scale (150Hz) Sampling time: 250mS Output operation: P.I.D control Output limit: -5.0~105.0% range, higher limit(OH) or lower limit(OL) selectable (valid when AT)

FUNCTION

Measurement input	Input correction (Bias): -100.0~100.0% for instrument range Scaling : According to SH, SL of measurement range Filter : OFF, 1~120 sec.
Control	3 settings (SV1, SV2 and SV3) and P.I.D setting each Auto tuning : According to set value (Standard type, Low PV type) Proportional Band : 0.1~999.9% (Max. range), 0.0~999.9% (When heating - cooling control) Integral Time : OFF, 1~6000 sec. Derivative Time : OFF, 1~6000 sec. ON/OFF control: By selecting output code (OT) " 0 " P.I.D selection : Zone PID/Segment PID selectable Manual Reset : -5.0~105.0% of output (valid when l=OFF) Direct / Reverse action : Changeable by parameter Preset output limit : -5.0~105.0% of output value, 0.0~105.0% when heating, cooling control ON/OFF hysteresis (HYS): 0.0~100.0% of instrument range (valid when ON/OFF control) Heating-Cooling hysteresis : -100.0~50.0% of output value A.R.W(Anti Reset Wind-up): AUTO, 50.0~200.0% Fuzzy : selection ON/OFF by parameter
Retransmission output	Signal : Process value(PV), Set value(SV), Output value(MV) Scaling : PV, SV
Alarm output	Set point : Refer to terminal arrangement Multi-alarm : High/Low process alarm, High/Low deviation alarm, Hold function of alarm, Heater break alarm (H.B.A) Setting range : Process alarm 0~100% of instrument range Deviation alarm -100~100% of instrument range Alarm hysteresis : 0.0~100.0% of instrument range

POWER SUPPLY

Power supply	100~240VAC(90~264VAC)	24V AC • UDC(will be available in May,2000)
Frequency	50/60Hz	
Power consumption	6.0W max., 10VA max..	
Insulation resistance	Between primary terminal and secondary terminal : DC 500V, 20M Ω min. Between primary terminal and ground : DC 500V, 20M Ω min. Between ground and secondary terminal : DC 500V, 20M Ω min.	
Dielectric strength	Between primary terminal and secondary terminal : 2,300VAC 50/60Hz for 1 min. Between primary terminal and ground : 2,300VAC 50/60Hz for 1 min. Between P ⁺ SG and secondary terminal : 1,500VAC 50/60Hz for 1 min.	
Power supply for sensor	24VDC 20mA (But, it is not available in retransmission output)	

INTERFACE

Standard	EIA RS485
Communication address	0~31, 1~99 setting available
Communication method	2 wire half duplex or 4 wire half duplex
Synchronization	Start-stop synchronous mode
Communication sequence	None
Communication distance	1.2Km max.
Communication speed	600, 1200, 2400, 4800, 9600 BPS (Speed is changeable by parameter)
Start bit	1 BIT
Data bit	7 or 8 BIT
Parity bit	None, even numbers, odd numbers
Stop bit	1 or 2 BIT
Communication protocol	PC LINK WITHOUT SUM(0), PC LINK WITH SUM(1)
Response time	Reception treatment time + (Response time × 10mS)

DIMENSIONS & PANEL CUTOUT

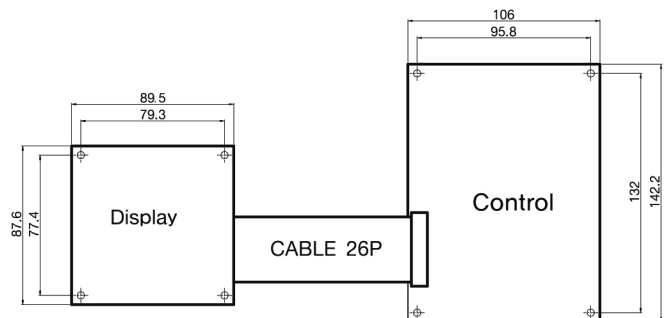

※Cable length basically 300 mm

■ Display

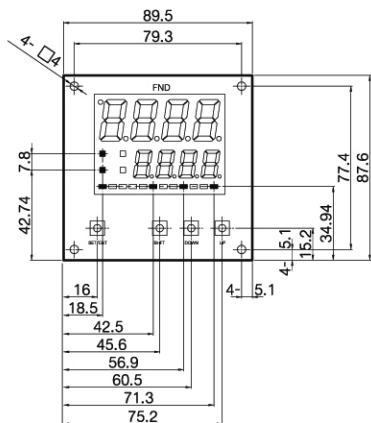

■ Control

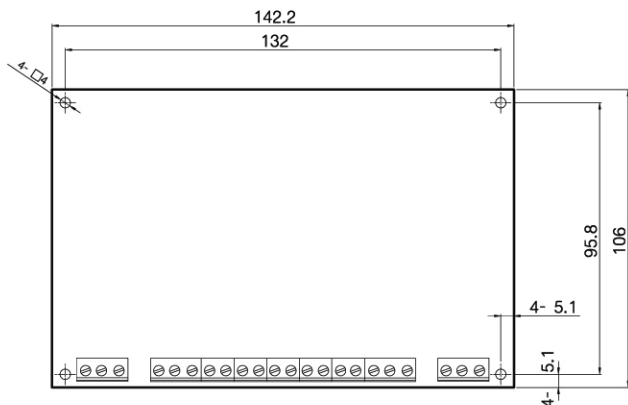

■ Input / Output circuit

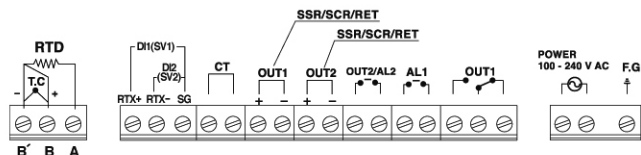

■ Name of parts

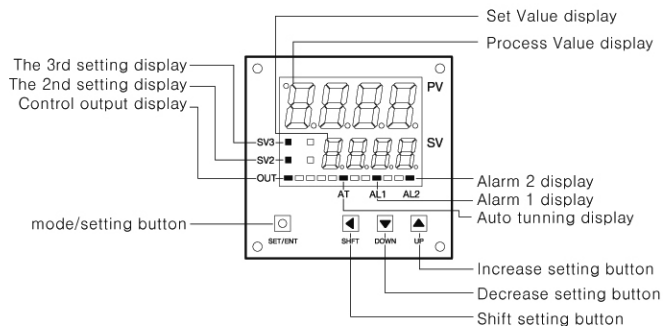

■ TABLE OF SETTING ITEMS

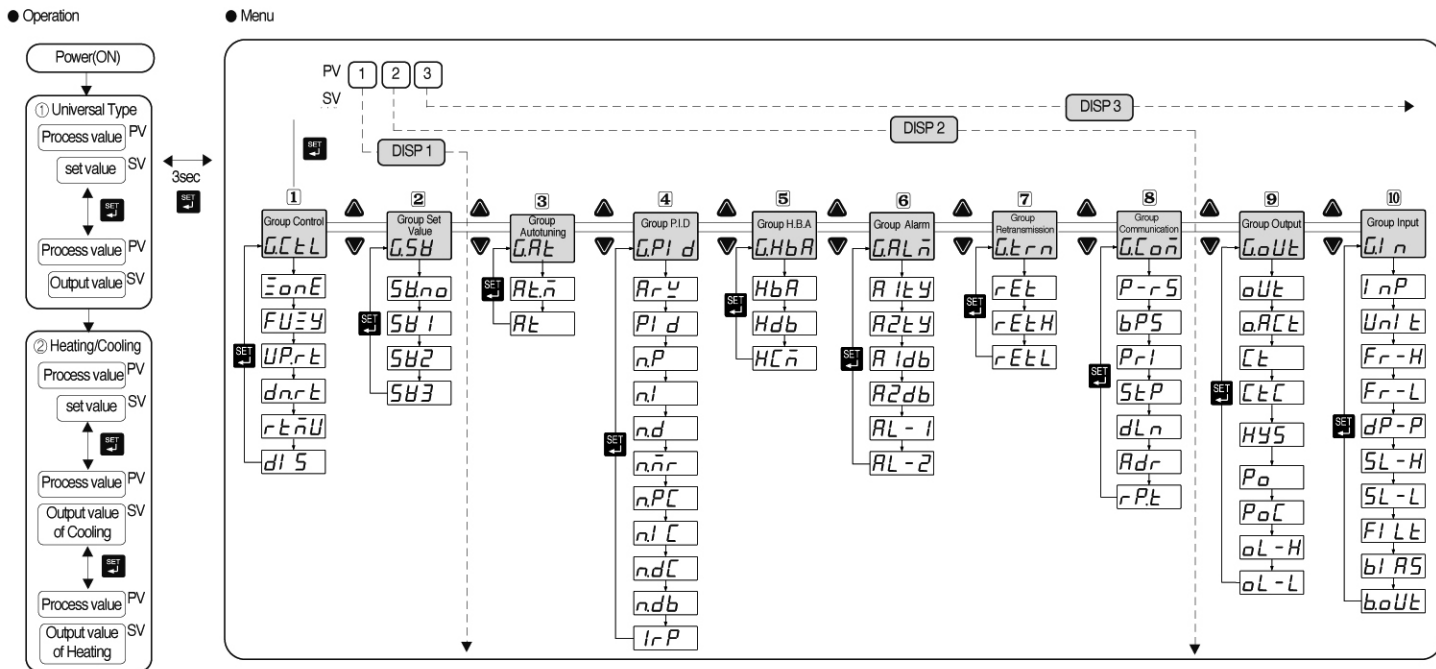

■ DISP1 Group setting

■ CONTROL GROUP

- Control zone, fuzzy function, and ramp function are available.
- Fuzzy function is operating in the P.I.D control. (not operating in the ON/OFF control)
- Using two external contact input (SV2, SV3) as ON/OFF, it is possible to control 3 kinds setting values.

DIS selection	Set value selection by external contact signal		
OFF	No external contact signal		
ON	External signal	SV2	SV3
	Display		
	SV1 Display	OFF	OFF
	SV2 Display	ON	OFF
	SV3 Display	OFF	ON

Signal	Name	Operation	Display condition	Initial Value
	Control group display	Set a control mode	-	-
	Zone selection 1	OFF / ON	Always	OFF
	Fuzzy function selection	OFF / ON	P.I.D control	OFF
	Initial increasing temperature	OFF / EUS(0~100%)	Always	OFF
	Initial decreasing temperature	OFF / EUS(0~100%)	Always	OFF
	Time unit	HOUR / MIN	Always	HOUR
	External contact input selection	OFF / ON(Refer to chart 1)	Always	OFF

■ SET VALUE GROUP SETTING

Signal	Name	Description	Condition	Initial Value
	Set value group	Set value setting	-	-
	Select number of set value	1~3(Display and control a set value which is selected in 3 types.)	Always	1
	Set SV 1	*EU(0.0~100.0%)		EU(0.0%)
	Set SV 2	EU(0.0~100.0%)		EU(0.0%)
	Set SV 3	EU(0.0~100.0%)		EU(0.0%)

- * EU : Value at an engineering unit in compliance with the range of an instrument.
- * In this setting group, 3 type of set value are set as SV1, SV2 and SV3. After setting set value, select each set value from external contact signal to control.

■ DISP2 Group setting

■ AUTO TUNING

Signal	Name	Description	Condition	Initial Value
	Auto tuning group	Indicates Auto tuning	-	-
	Auto tuning type	Standard (STD) : S t d / Low PV (LOW) : L o w	ABS	STD
	Auto tuning start	OFF / 1~3 / R U t o (AUTO)	ABS	OFF

This Digital temperature controller has two types of auto-tuning as STD (Standard type) and LOW (Low PV type : SV - 10%. Low PV type is the value 10% lower than the set value. Use this type where overshoot is to be suppressed.

- * Auto-tuning: The Auto-tuning function automatically measures, computes and set the optimum P.I.D and ARW constants. The Auto-tuning function can be activated at any time during the process after power ON : while temperature is rising or when control has stabilized.
- Auto tuning is not operated when selecting "OFF" in selection mode of auto tuning start and when selecting 1~3, among 3 kinds set value (SV1, SV2, SV3) selecting number will be auto tuned "Auto" mode will be operated when ZONE is ON. When setting a value on 1.rp 2.rp, it is separated in group 1, 2, 3.

■ P.I.D GROUP

Signal	Name	Description	Condition	Initial Value
	P.I.D group	Set P.I.D mode	-	-
	Anti Reset Wind-Up	Auto / 50.0~200.0%	P.I.D control	Auto
	P.I.D group selection	0 / 1~3	Always	0
	n. Proportional band(P)	0.1 (HC TYPE:0.0)~999.9%	P.I.D group	5.0%
	n. Integral time (I)	OFF / 1~6000 sec.	Always	240 sec.
	n. Derivative time (D)	OFF / 1~6000sec.	Always	60 sec.
	n. Manual reset	-5.0~105.0%	Integral time: OFF	50.0%
	n. Proportional band of cooling side (P)	0.0(ON/OFF CONTROL) / 0.1~999.9	Heating • Cooling type	5.0%
	n. Integral time of cooling side (I)	OFF / 1~6000 sec.	Heating • Cooling type	240 sec.
	n. Derivative time of cooling side (D)	OFF / 1~6000 sec.	Heating • Cooling type	60 sec.
	n. Hysteresis	-100.0~50.0%	Heating • Cooling type	3.0%
	n. Zone point	EU (0) < 1.RP < 2.RP < EU (100.0%)	ZONE = ON	EU(100.0%)

When checking P.I.D. values or setting SV in manual mode, this can be done in P.I.D. Group.

Press key to get Anti Reset Wind up value by auto or manual and then press once more to be indicated P.I.D mode which is selectable 3 types of P.I.D group (0-3). Example, "0" is no P.I.D mode and after selecting "1" using or and pressing, it is available to change P.I.D value in zone "1"

(* "2" and "3" are same as "1")

When integral time is 0, manual reset mode is indicated and then you could set reset value to remove off set. (range: -5%~105.0% of proportional band). You could set 3 zones by selecting zone mode ON.

* In diagram, "I" is available to set 1~3 and proportional band of cooling side, integral time of cooling side, hysteresis are indicated in Heating / Cooling type.

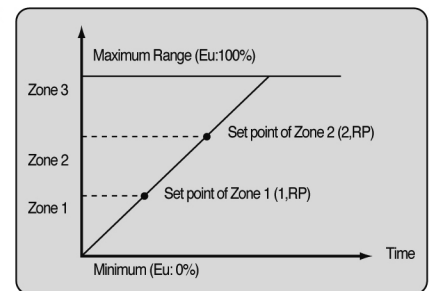

■ HEATER BREAK ALARM GROUP

Signal	Name	Description	Condition	Initial Value
	Heater break alarm group	Set HBA mode	-	-
	Current setting mode of HBA	OFF / 1~50A	Optional	OFF
	Hysteresis setting mode HBA	EUS (0.0~100.0%)		EUS(0.5%)
	Current measurement value of HBA	Only display (0~50A)		

Heater break alarm group consist of output dead band and current detection display mode and detects 2 spots (to be ordered separately : current transformer mode CTL-6-S, Measuring range : 1 - 5 A)

■ ALARM GROUP SETTING

Signal	Name	Operation	Condition	Initial Value
	Alarm group	Set alarm mode	-	-
	Type of Alarm 1	OFF / 1~22	Always	1
	Type of Alarm 2	Refer to "Alarm type and code"		2
	Dead band of Alarm 1	EUS (0.0~100.0%)	Always	EUS(0.5%)
	Dead band of Alarm 2			
	Set value of Alarm 1	PV alarm, Deviation alarm	Always	EUS(100.0%)
	Set value of Alarm 2	EU (-100.0~100.0%)		EUS(0.0%)

* Reference : Display lamp will be OFF when output ON in inverted type.

* In Heating/ Cooling type of, * is not indicated when selecting 10,11,12

ALARM TYPE AND CODE

※(Notice) : Display lamp will be ON when output OFF in inverted type.

Hysteresis (△ : Set point, -▲ : Minus Alarm set point, ▲ : Alarm set point)

Code No.	Alarm type	Function
1	High absolute value	
2	Low absolute value	
3	High deviation value	
4	Low deviation value	
5	High deviation value (inverted)	
6	Low deviation value (inverted)	
7	High\$Low deviation value	
8	High\$Low band	
9	High absolute (inverted)	
10	Low absolute (inverted)	
11	High absolute with hold function	
12	Low absolute with hold function	
13	High deviation with hold function	
14	Low deviation with hold function	
15	High deviation with hold function(inverted)	
16	Low deviation with hold function(inverted)	
17	High\$Low deviation with hold function	
18	High\$Low band with hold function	
19	High absolute value with hold function (inverted)	
20	Low absolute value with hold function(inverted)	
21	Heater break alarm 1 (HBA 1)	

RETRANSMISSION GROUP

Signal	Name	Description	Condition	Initial Value
	Retransmission group	Set retransmission mode	※ Reference	-
	Retransmission type or Power for sensor	PV / SV / Output volume (MV) / Power for sensor (SPS)	Optional	PV
	High limit of retransmission	Thermocouple / R.T.D : FR -H ~ FR-L DC voltage : SL -H ~ SL-L	PV / SV	
	Low limit of retransmission	but, RET. H > RET.L set alarm mode		

In retransmission output mode, process value (PV), set value (SV), output volume (MV) or power supply for sensor will be selected and set maximum value and minimum value of, retransmission output.

※ Reference : Retransmission group will be indicated when selecting retransmission in output group.

If selecting code 4,5,7 or 8 in output group, retransmission will not be indicated.

COMMUNICATION

Signal	Name	Description	Condition	Initial Value
	Communication group	Set communication mode	-	-
	RS 485 / RS 422 Protocol	PC.LINK(Set value:0) / PC.LINK SUM (Set value:1)	Optional	0
	Communication rate (B.P.S)	600(SV:0) / 1200(SV:1) / 2400(SV:2) 4800(SV:3) / 9600(SV:4)		4
	Parity check	NONE(SV:0)/EVEN(SV:1)/ODD(SV:2)		1
	Stop bit	1bit (SV:1) / 2bit (SV:2)		1
	Data length	7bit (SV:7) / 8bit (SV:8) (Except PC LINK :8)		8
	Address	1~99 , maximum 31 devices		1
	Response time	0~10. response time = (handling time + response time) X 10ms		0

BX8 series are equipped with 4 wire /2 wire half-duplex the RS485 / RS422 communication interfaces. Using the interfaces, communications are available with maximum 31 devices.

DISP3 Group setting

INPUT GROUP SETTING

CAUTION

When setting, "Input type selection number" must be selected in the input type selection mode and also "Output type selection number" must be selected in the output type selection mode before moving to other mode.

If not, data of other group will be changed to prior value.

Signal	Name	Description	Condition	Initial Value
	Input group	Input type and mode selection	-	-
	Input signal selection	Refer to input signal and range	Always	Selection NO.1
	Measurement range unit	°C / °F	Thermocouple or R.T.D	°C
	High limit	Refer to input signal and range	Always	1370
	Low limit	(Notice : FR-H > FR-L)	Always	-200
	Decimal point(on voltage input)	Thermocouple or R.T.D : decimal point of instrument / DC Voltage : 0-3	On voltage input (mV,V)	1
	Maximum on scale (on voltage input)	-1999~9999 Notice : SL-H > SL-L	On voltage input (mV,V)	100.0
	Minimum on scale (on voltage input)	Deimal point : according to DP-P		0.0
	PV filter	OFF/1~120sec	Always	OFF
	PV bias	EUS (-100.0~100.0%)	Always	EUS(0.0%)
	Burn-out	OFF / UP / DOWN	Always	UP

INPUT SIGNAL and MEASUREMENT RANGE

Input type (Input signal)	Input code	Range (°C)	Range (°F)	Accuracy	Remarks	
Thermo couple (T.C)	K × 2	1	-200~1370	-300~2500	± 0.5 % of F.S ± 1digit	※ U.F.S is maximum value ~ minimum value of each RANGE ※ U.Digit is minimum value of display ※ 1.0~400 °C : ± 10% of F.S ± 1digit ※ 2.0 °C and below : ± 1.0% of F.S ± 1digit ※ 3-150.0~150.0 °C range : ± 1.0% of F.S ± 1digit ※ 21 → KP1100 ※ 21 → DP1100
	K × 2	2	-199.9~999.9	0~2300		
	J × 2	3	-199.9~999.9	-300~2300		
	E × 2	4	-199.9~999.9	-300~1800		
	T × 2	5	-199.9~400.0	-300~750		
	R × 2	6	0~1700	32~3100		
	B × 1	7	0~1800	32~3300		
	S	8	0~1700	32~3100		
	L × 2	9	-199.9~900.0	-300~1300		
	N	10	-200~1300	-300~2400		
	U × 2	11	-199.9~400.0	-300~750		
	W	12	0~2300	32~4200		
	R.T.D	Platinel II	13	0~1390		
KSP1100 Ω × 3 ※		20	-199.9~500.0	-199.9~999.9		
Pt100 Ω × 3 ※		21	-199.9~640.0	-300~1180		
Direct voltage (VDC / mVDC)	1-5 V d.c	30	1-5 V d.c	± 0.5 % of F.S ± 1digit	※ 20 → KP1100 ※ 21 → DP1100	
	-10-20 mV d.c	32	-10-20 mV d.c			
	0-100 mV d.c	33	0-100 mV d.c			
Direct voltage (mV)	4-20 mA d.c	30	※ When using current input, use the resistor 250 Ω 0.1% on input terminal.			

OUTPUT GROUP SETTING

Signal	Name	Description	Condition	Initial Value
	Output group	Output type and mode selection	-	-
	Output signal	Refer to type of control output	Always	(0/3)
	Output operation	REV: Reverse DIR: Direct action	Output code 1-3	REV
	Cycle time	1~1000 sec	Relay / SSR	30 sec
	Cycle time of cooling output	1~1000 sec	Output code 4~12	30 sec
	Hysteresis of universal type	EUS(0.0~100.0%)	ON/OFF Control	EUS(0.5%)
	Hysteresis of Heating/Cooling type	0.0~10.0%	Heating/Cooling	0.5%
	Output volume when input disconnection Output 1 (Out1)	Universal : -5.0~105.0% Heating / Cooling : 0.0~105.0%	Always	0.0%
	Output volume when input disconnection Output 2 (Out2)	0.0~105.0%	Heating/Cooling	0.0%
	Maximum value of output	Universal : OL-L + 1Digit ~ 105.0% Heating / Cooling : 0.0~ 105.0%	PID Control	100.0%
	Minimum value of output	Universal : -0.5%~ OL-H-1Digit Heating / Cooling : 0.0~ 105.0%	PID Control	0.0 % 100.0%

This Digital temperature controller is divided into 2 type: UNIVERSAL TYPE AND HEATING / COOLING TYPE Output is selectable from Relay, SSR and Current (4~20mA DC)

Output type range (output code) is ①~③ for universal type and ④~⑫ for Heating /Cooling type. Sometimes retransmission output and alarm output are not available according to control output

※ NOTE : The HBA is not available on SCR control output

● Universal type

Universal type	Output code(OT)	OUT1		OUT2	
		Relay	SSR / SCR(Current)	Relay	SSR / SCR(Current)
BX8 - 0□	0	Relay (ON/OFF control)		AL2	Retransmission
	1		SSR	AL2	Retransmission
	2		SCR	AL2	Retransmission
	3	Relay		AL2	Retransmission

● Heating / Cooling type

Heating / Cooling type	Output code (OT)	Heating (OUT1)		Cooling (OUT2)	
		Relay	SSR/SCR(Current)	Relay	SSR / SCR / RET
BX8 - 1□	4		SSR	AL2	SSR
	5		SCR	AL2	SSR
	6	Relay	RET	AL2	SSR
	7		SSR	AL2	SCR
	8		SCR	AL2	SCR
	9	Relay	RET	AL2	SCR
	10		SSR	Relay(AL2)	Retransmission
	11		SCR	Relay(AL2)	Retransmission
	12	Relay		Relay(AL2)	Retransmission

(EX. when you choose output code (OT) 2, it is current output of Universal type. In this case, retransmission output and alarm output are available. But, In Heating / Cooling control type with SSR on Heating side and Relay output on Cooling side (output code ⑩), the retransmission output is available but alarm output 2 is not available.

■ AUTO-TUNING in Zone PID

Zone PID automatically sets PID group in accordance with a measured value. In Zone PID, auto-tuning sets the proper PID value by recognizing a mid-value of reference point as set point value.

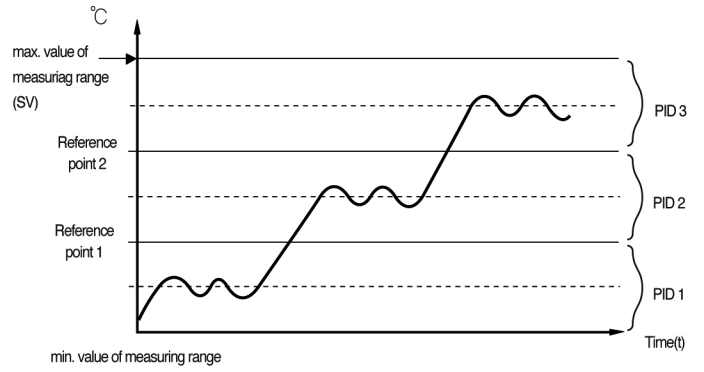

■ Ramp function

It is a rate of set value to arrive to initial set value (SV1, SV2, SV3) according to setting temperature and time.

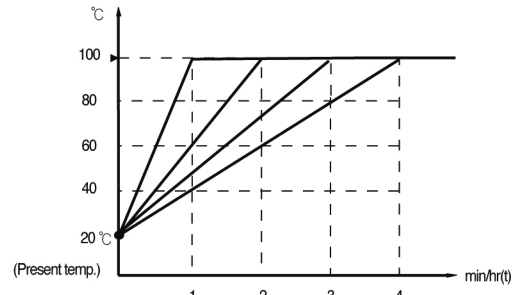

● EXTERNAL CONTACT INPUT

Optional SV will be selected among SV1, SV2, and SV3 by external contact input. It will be used as step control.

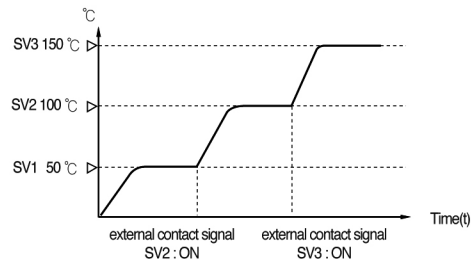

● OUTPUT LIMIT

Control output is set in high and low limit as operating range. Output limit is -5~105% of output.

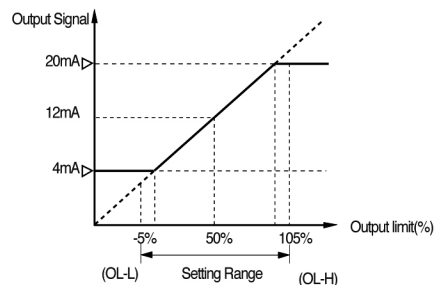

■ FUNCTION

■ AUTO TUNING

The Auto tuning function automatically measures, computes and sets the optimum Proportional band(P), Integral time(I), and Deri-vative time(D). When Auto-tuning, the controller performs ON/OFF control and determine proper P,I and D. (Limit cycle type)

BX8 controller have two types of Auto-tuning as below.

① Standard type auto-tuning :

This type is based on set point value (SV)

② Low PV type auto-tuning :

This type is based on the value 10% lower than the set point value (SV)

a) STANDARD TYPE AUTO-TUNING

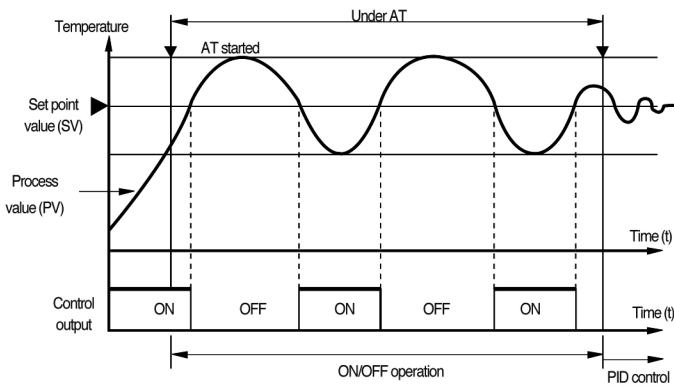

b) LOW PV TYPE AUTO-TUNING

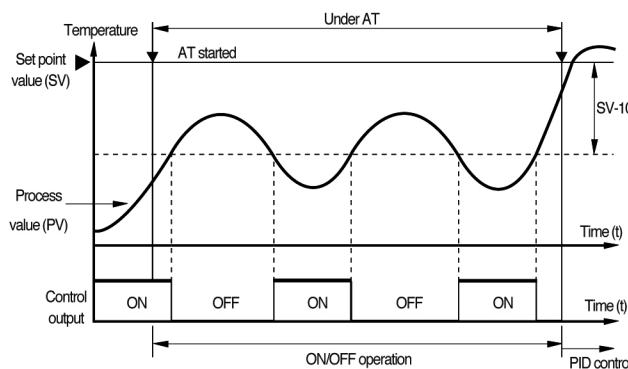

● FUZZY CONTROL

Fuzzy control eliminates overshoot using Fuzzy Logic.

Employing Fuzzy control and Auto-tuning, the controller effectively control as below.

- ① When the controller starts control at the position which has a big gap between SV and PV.
- ② When reducing warming up time
- ③ When the load is fluctuating extremely
- ④ When changing a set point value frequently

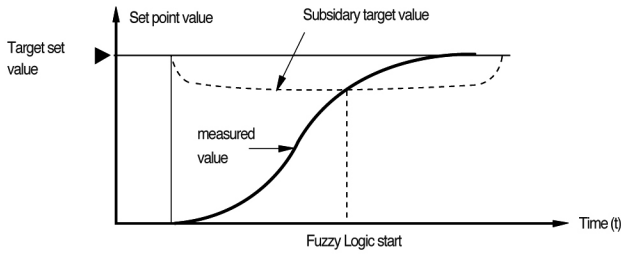

● HEATER BREAK ALARM(HBA)

Set-value of HBA to be set about 85% to input of CT but the set-value should be less in case that the ratio of voltage variation is high. HBA detects an heater disconnection and makes an alarm operation.

- ① Using current transformer (CT) designated by HANYOUNG.
- ② Set using voltage and set-value of HBA by front keys.
- ③ Phase angle control type by thyristor could not use. (SCR Output)

● HEATING / COOLING CONTROL

Heating / Cooling control output two signal divided for heating and cooling. It is available to output PID control or ON / OFF control in heating side and cooling side each, also could select a output among relay, SSR, or current output (4~20mA).

When heating and cooling side are ON / OFF control, hysteresis will be shown as below.

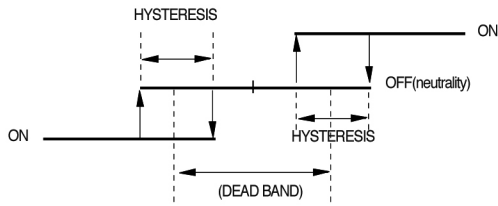

When heating and cooling side are PID control, hysteresis will be shown as below.

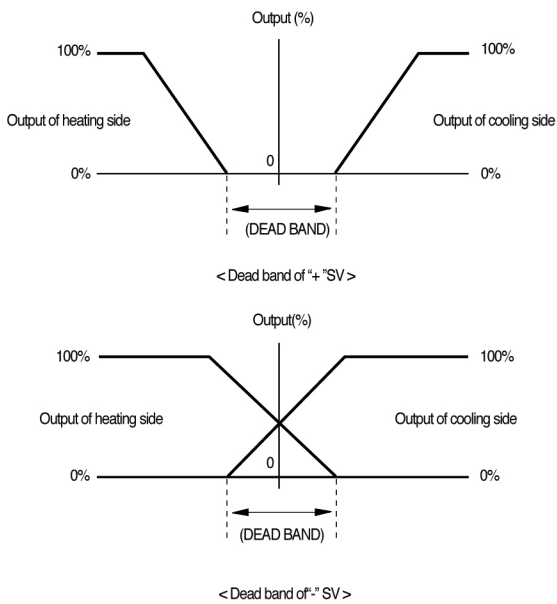

● Emergency output

When A/D error or input disconnection occur in auto mode, PID output is cut and then Pre-set output is operated. (PO Output)

● Hold function

Without hold function, Low limit alarm will be ON when increasing temperature. (Picture 1)

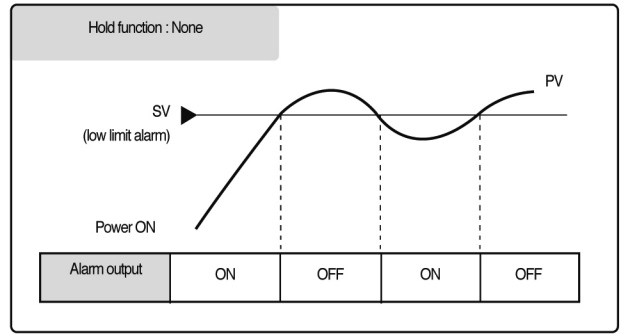

(Picture 1)

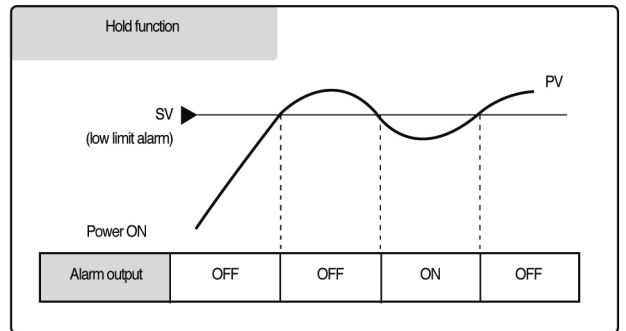

(Picture 2)